

Installation and User's Guide

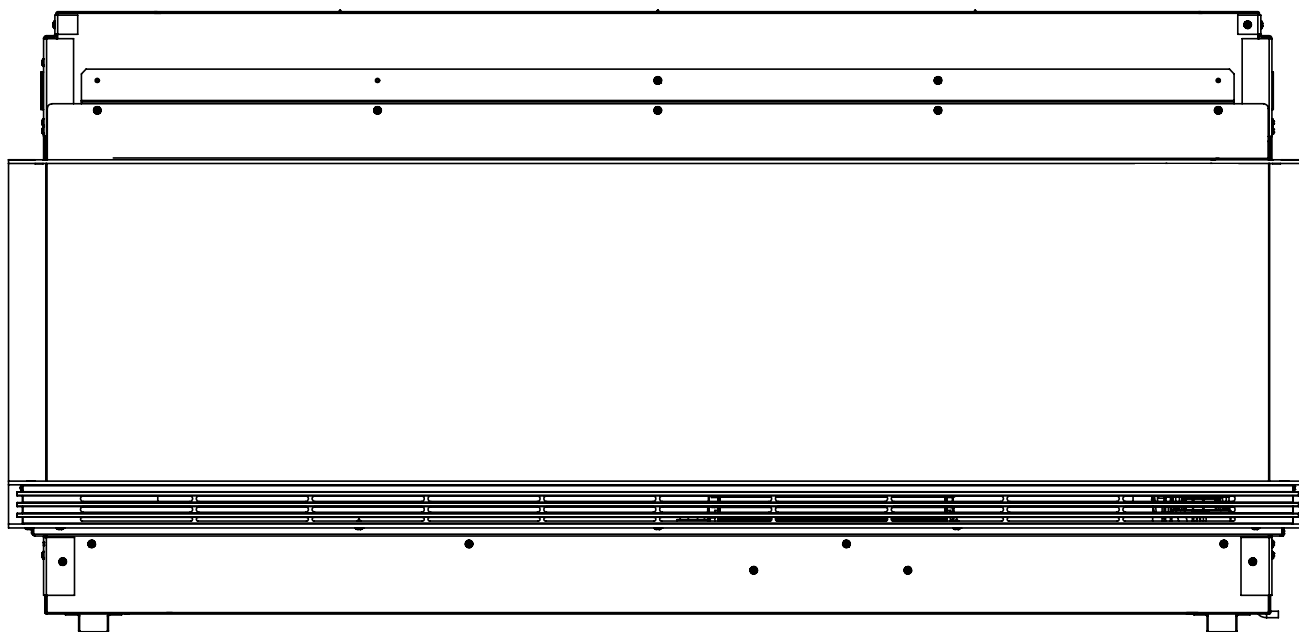

EN

DE

FR

NL

IMPORTANT SAFETY INFORMATION:

Read this manual first before attempting to install or use this electric fire. Always comply with the warnings and safety instructions contained in this manual and presented on the appliance to prevent personal injury or property damage.

The product complies with the required Product Safety, Electromagnetic Compatibility and Environmental Standards. This product is fully compliant with LVD, EMC, RoHs and EcoDesign Directives.



EN: This product is only suitable for well insulated rooms or occasional use. DE: Dieses Produkt ist nur für gut isolierte Bereiche oder gelegentliche Verwendung geeignet. FR: Ce produit convient uniquement à des endroits bien isolés ou pour un usage occasionnel. IT: Questo prodotto è adatto solo per spazi ben isolati o per uso occasionale. ES: Este producto sólo es adecuado para espacios bien aislados o un uso ocasional. NL: Dit product is uitsluitend geschikt voor goed geïsoleerde ruimten of voor sporadisch gebruik. PL: Produkt ten jest odpowiedni wyłącznie do dobrze odizolowanych miejsc lub do okazjonalnego użycia. NO: Dette produktet egner seg kun for godt isolerte rom eller sporadisk bruk. RO: Acest produs este adecvat exclusiv spațiilor bine ventilate sau utilizării ocazionale. CZ: Tento výrobek je vhodný pouze do dobře izolovaných prostor nebo k příležitostnému použití. DK: Dette produkt er kun egnet til velisolerede rum eller lejlighedsvis brug. PT: Este produto somente é adequado para espaços bem isolados ou uso ocasional. SE: Denna produkt är endast avsedd för välisolerade utrymnen eller tillfällig användning. FI: Tämä tuote soveltuu ainoastaan hyvin eristettyihin tiloihin tai satunnaiseen käyttöön. SK: Tento výrobok je vhodný len pre dobre izolované priestory alebo na občasné použitie. SI: Ta izdelek je primeren le za dobro izolirane prostore ali za obasno uporabo. HR: Ovaj proizvod je pogodan samo za dobro izolirane prostore ili povremenu upotrebu. HU: Ez a termék csak jól szigetelt terekhez vagy eseti használatra alkalmas.

Table of Contents

Welcome	3
Important Instructions	4
Technical Specifications	6
Electrical Requirements	6
Technical Information	6
Product Dimensions	6
Package Contents	7
Installation	8
Install Mounting Brackets	8
Install the Cord Set	8
Install the Mirrored Glass	9
Prepare Framing	9
Media Arrangement	11
Install the Side Glass Panels and Front Glass	11
Installation Finishing	11
Operation	12
General Operation	12
Timer	12
Remote Operation	12
Resetting the Temperature Cutoff Switch	12
Icon Operations	13
Timer Operation	14
Maintenance	15
Remote Control Battery Replacement	15
Flame Screen Cleaning	15
Fireplace Surface Cleaning	15
Servicing	15
Troubleshooting	16

Welcome

MODEL NUMBER AND SERIAL NUMBER

Please record your model and serial numbers for future reference.

Model _____

Serial Number _____

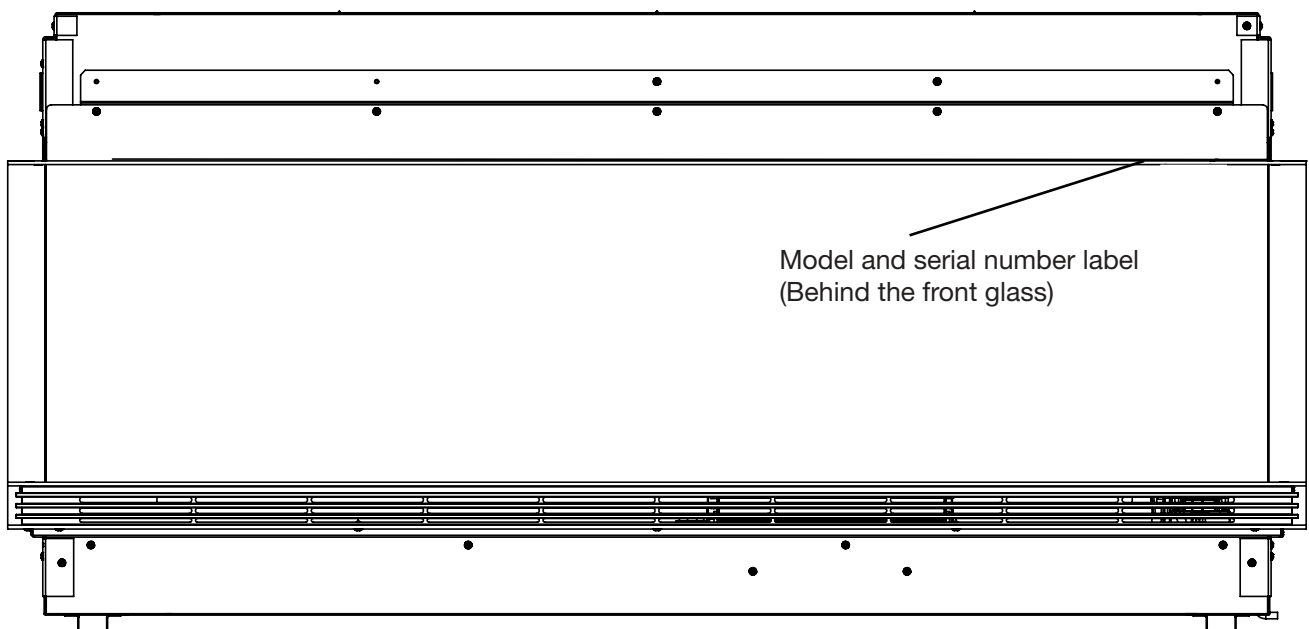

NO NEED TO RETURN TO THE STORE



If you have questions regarding the operation of this product or if you require service, before returning this product to the place of purchase...

Contact us for troubleshooting and technical support



Please have your model number and product serial number ready.

SAVE THESE INSTRUCTIONS

IMPORTANT INSTRUCTIONS

CAUTION: FAILURE TO FOLLOW THESE INSTRUCTIONS MAY CAUSE INJURY AND/OR DAMAGE AND MAY INVALIDATE YOUR GUARANTEE

Important Safety Advice

When using electrical appliances, basic precautions should always be followed to reduce the risk of fire, electrical shock and injury to persons, including the following:

- If the appliance is damaged, check with the supplier before installation and operation.
- Do not use outdoors.
- Do not use in the immediate surroundings of a bath, shower or swimming pool.
- Do not locate the appliance immediately below a fixed socket outlet or connection box.

Warning: This heater must not be used for anything other than normal domestic household purposes in the country where it was purchased from a recognised commercial retailer.

Do not use this heater if it has been dropped

Do not use if there are visible signs of damage to the heater.

Use this heater on a horizontal and stable surface, or fix it to the wall, as applicable.

Children of less than 3 years should be kept away unless continuously supervised. Children aged from 3 years and less than 8 years shall only switch on/off the appliance provided that it has been placed or installed in its intended normal operating position and they have been given supervision or instruction concerning use of the appliance in a safe way and understanding the hazards involved. Children aged from 3 years and less than 8 years shall not plug in, regulate and clean the appliance or perform user maintenance.

CAUTION: Some parts of this product can be very hot and cause burns. Particular attention has to be given where children and vulnerable people are present.

This appliance can be used by children aged from 8 years and above and persons with reduced physical, sensory or mental capabilities or lack of experience and knowledge if they have been given supervision or instruction concerning use of the appliance in a safe way and understand the hazards involved. Children shall not play with the appliance. Cleaning and user maintenance shall not be made by Children without supervision.

Warning: Do not use this heater in small rooms when they are occupied by persons not capable of leaving the room on their own, unless constant supervision is provided.

Warning: In order to avoid overheating, do not cover the appliance. Do not place material or garments on the appliance, or obstruct the air circulation around the appliance, for instance by curtains or furniture, as this could cause overheating and a fire risk.

The appliance carries a "Do Not Cover" warning. 

Warning: To reduce the risk of fire, keep textiles, curtains, or any other flammable material a minimum distance of 1m from the air outlet.

Warning: In order to avoid a hazard due to inadvertent resetting of the thermal cut-out, this appliance must not be supplied through an external switching device, such as a timer, or connected to a circuit that is regularly switched on and off by the utility.

IMPORTANT INSTRUCTIONS

WARNING: KEEP BATTERIES OUT OF REACH OF CHILDREN

- Swallowing may lead to serious injury in as little as 2 hours or death, due to chemical burns and potential perforation of the oesophagus.
- If you think batteries might have been swallowed or placed inside any part of the body seek immediate medical attention
- Examine devices and make sure the battery compartment is correctly secured, e.g. that the screw or other mechanical fastener is tightened. Do not use if the compartment is not secure.
- Dispose of used button batteries immediately and safely. Flat batteries can still be dangerous.

CAUTION: No obvious symptoms

Unfortunately, it is not obvious when a button or coin battery is stuck in a child's oesophagus (food pipe).

There are no specific symptoms associated with this. The child might:

- cough, gag or drool a lot;
- appear to have a stomach upset or a virus;
- be sick;
- point to their throat or stomach;
- have a pain in their abdomen, chest or throat;
- be tired or lethargic;
- be quieter or more clingy than usual or otherwise "not themselves";
- lose their appetite or have a reduced appetite; and
- not want to eat solid food/be unable to eat solid food.

These sorts of symptoms vary or fluctuate, with the pain increasing and then subsiding.

A specific symptom to button and coin battery ingestion is vomiting fresh (bright red) blood. If the child does this seek immediate medical help.

- The lack of clear symptoms is why it is important to be vigilant with "flat" or spare button or coin batteries in the home and the products that contain them.

<p> WARNING</p> <p>KEEP OUT OF REACH OF CHILDREN</p> <p>Swallowing can lead to chemical burns, perforation of soft tissue, and death. Severe burns can occur within 2 hours of ingestion. Seek medical attention immediately.</p>	
--	---



Technical Specifications

Electrical Requirements

⚠ WARNING: Construction and wiring must comply with local building codes and other applicable regulations to reduce the risk of fire, electric shock and injury to persons.

⚠ WARNING: To reduce the risk of fire, electric shock or injury to persons, always use a licensed electrician.

! NOTE: A dedicated, properly fused 13 Amp circuit is required, rated for the appropriate voltage (230-240V). An isolation switch should also be incorporated in cases where the product plug is inaccessible after installation.

Technical Information

Rating : 230-240V~50Hz

Heat Output		230V	-	240V	
Nominal Heat Output	P_{Nom}	1.8	-	1.9	kW
Minimum Heat Output	P_{min}	0.9	-	0.9	kW
Maximum Continuous Heat Output	$P_{max,c}$	1.8	-	1.9	kW

Auxiliary Electricity Consumption

In Standby Mode	el_{SB}	0.5	-	0.5	W
-----------------	-----------	-----	---	-----	---

with electronic room temperature control.

Product Dimensions



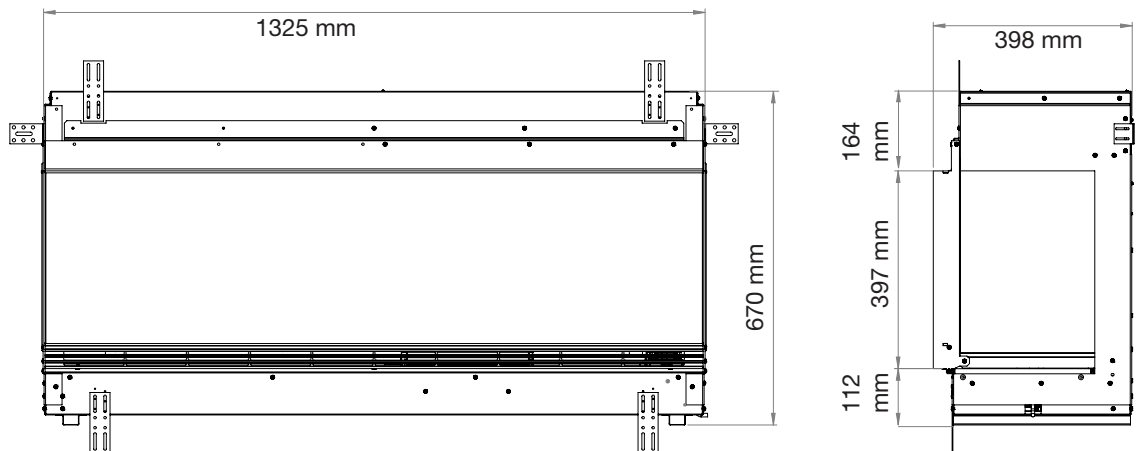



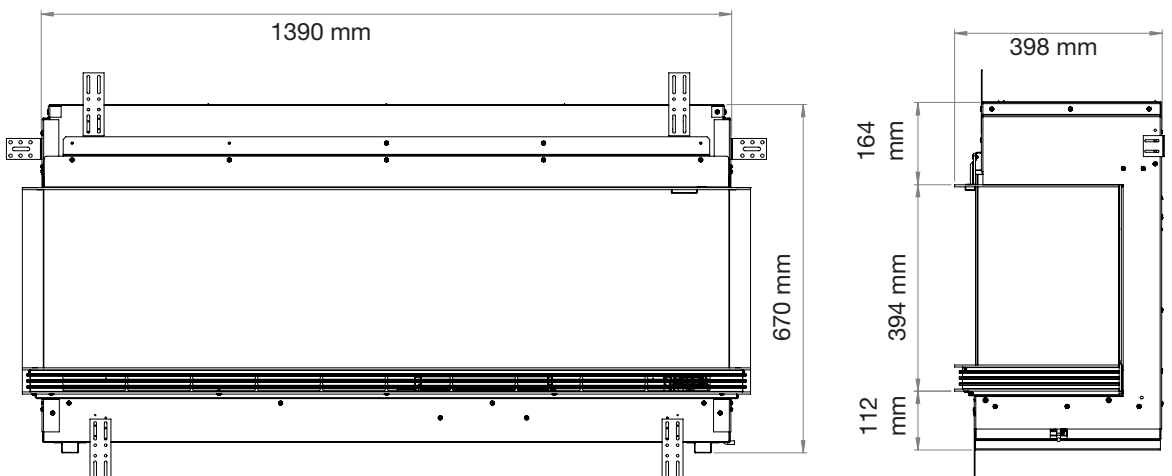

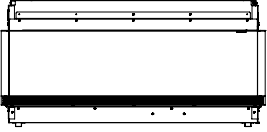

VST130 - I



VST130 - III

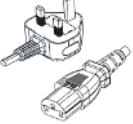

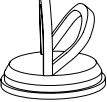
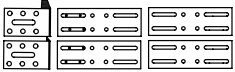
Package Contents

Image	Description	Quantity	
		VST130 - I	VST130 - III
	Firebox	1	1
	Front Glass	1	1
	Mirror Glass	1	1
	Side Glass	0	2
	Media Chips	~500g	~500g
	Remote Control	1	1
	User's and Installation Guide	1	1
	UK Cord Set	1	1
	EU Cord Set	1	1
 <p><i>Do not dispose of the suction cup after installation. Keep it in a secure location as it will be helpful for maintenance and service of the unit.</i></p>	Suction Cup	2	2
Hardware Kit			
	Mounting Brackets	6	6
	1" Wood Screws	6	6

Installation



! NOTE: Two people are required for installation.

⚠ WARNING: The top of the fireplace must be installed a minimum of 24" (61 cm) from the ceiling and a minimum of 15" (38 cm) from the ground.

1 Install the Mounting Brackets

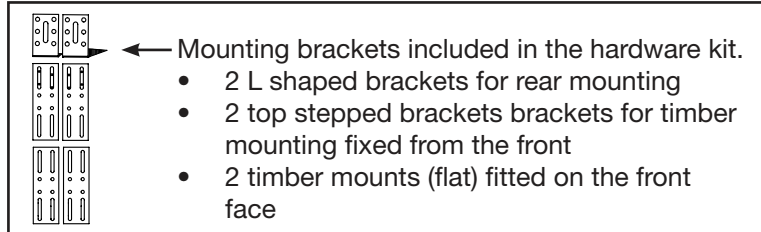

Carefully lay the firebox on its back and install the mounting brackets to the top and bottom of the firebox with the black screws provided.

! NOTE: The mounting brackets are equipped with slots to allow small adjustments to fit the framing. Ensure all the brackets are aligned.

! NOTE: There are 6 mounting brackets

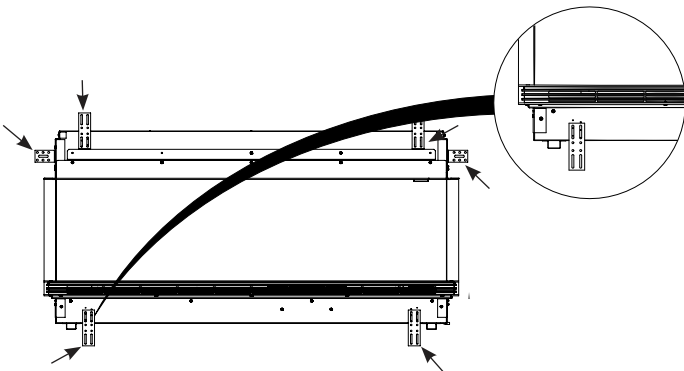

2 Install the Cord Set (if applicable)

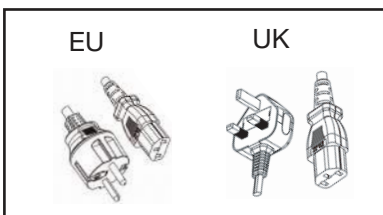

! NOTE: Ensure the internal rocker switch is in the OFF position. It is located on the inside of the unit at the top right side.

Install the suitable cord set if the incorrect set came installed on the unit. To access the cord set and IEC connector location, remove the base log set by removing the 3 screws. There is a screw at the back left, back right, and underneath the timer cover. The IEC connector is located at the bottom right side. Plug in the cord set, and secure it with the cable clamp provided. Run the cord through the exit opening.

! NOTE: 2 cord sets are provided (the EU or UK option) with the fireplace. A certified technician should install the suitable cord set based on local electrical requirements.

! NOTE: Reinstall the base log set after installing the cord set.

! NOTE: Ensure the earth connection is securely re-tightened.

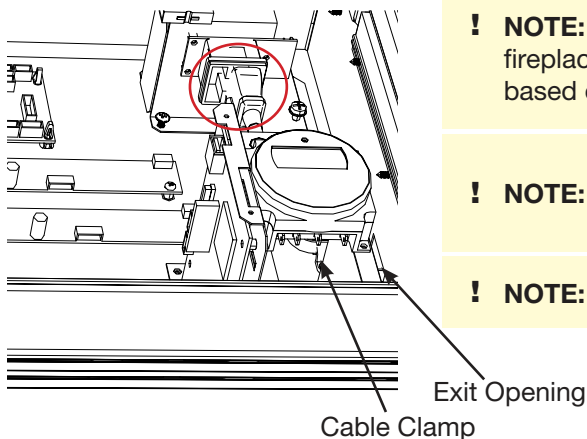

Installation

3 Install the Mirrored Glass

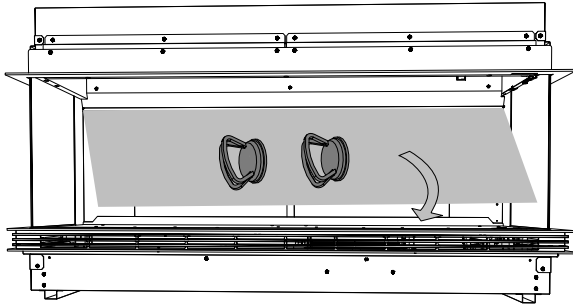
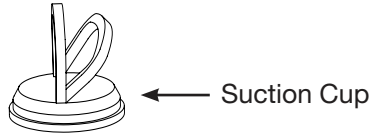

! NOTE: Remove the protective peel-off plastic before attaching the suction cups and ensure the suction cups are securely attached to the glass.

Attach the suction cups to the mirrored glass side where the protective plastic was removed. Place the mirrored glass in the top slot located at the back of the unit, then carefully place it in the bottom slot at an angle to secure it.

4 Wall Framing

Prepare a wall with a framed opening, following the dimensions in the table below.

Framing Dimensions

Model	Width	Height	Depth (minimum)
	A	B	C
VST130 - I	1335 mm	685 mm	400 mm
VST130 - III	1335 mm		

VST130-III Installation

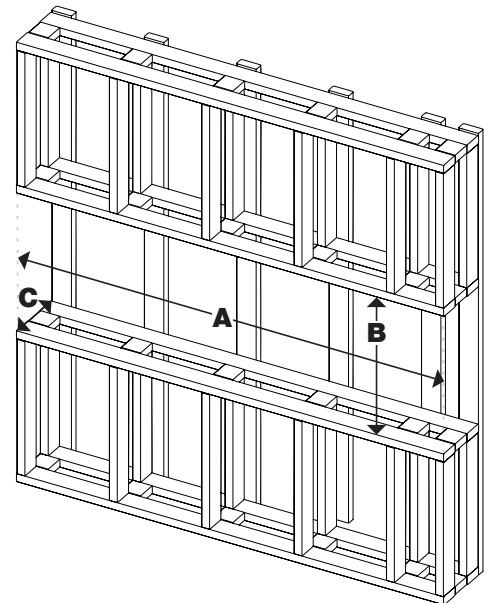

VST130 - I Installation

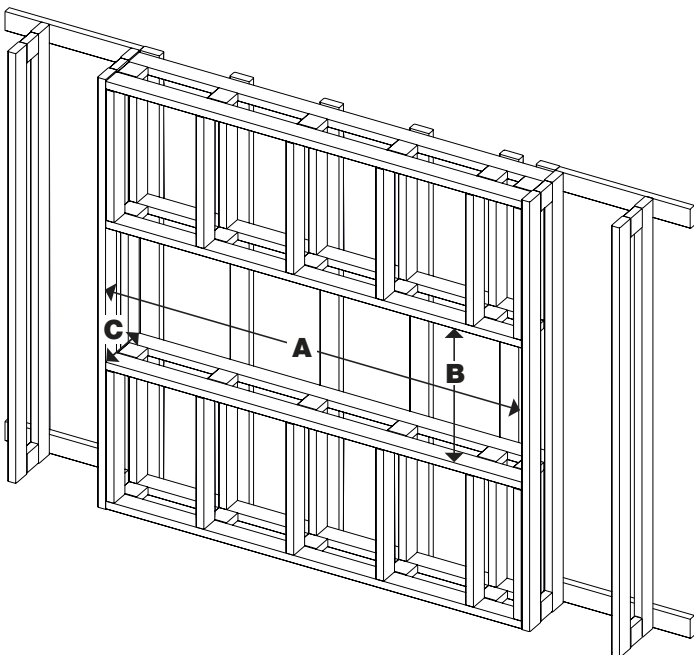

! NOTE: Ensure the product is within 1m of a power outlet.

! CAUTION: This fireplace is **NOT** load-bearing. Ensure the opening for the fireplace is framed in such a way that the weight of the building materials will not create pressure on the top of the fireplace.

! NOTE: The cord set is located at the bottom right back corner of the firebox. Plan the framing to allow routing the cord set to an outlet.

! NOTE: These framing dimensions are based on installation with 1/2" (12.7 mm) drywall.

! NOTE: Do not install the firebox into an air-tight enclosure. Ventilation to the unit is recommended to improve operation.

Installation

5 Place the Firebox into the Framing

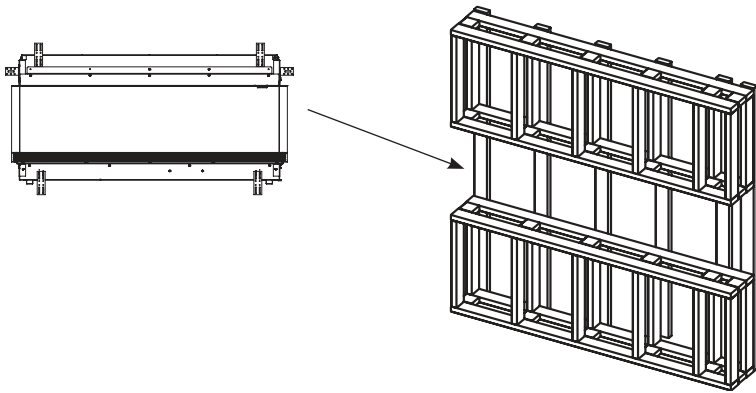

Lift the firebox into the opening of the framing.

6 Connect the Cord Set

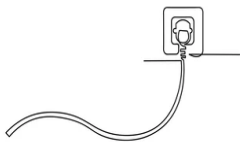

Plug the fireplace cord set into a 230V or 240V outlet.

7 Level the Firebox



Use a bubble level to ensure the firebox is level in the framing.

8 Secure the Mounting Brackets



← Wood screws included in the hardware kit.

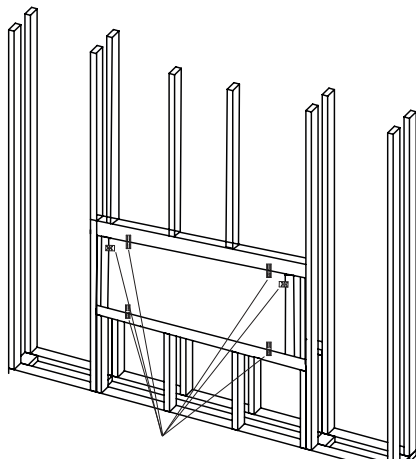

Mounting brackets

Secure the mounting brackets to the framing on both the top, bottom, and sides using the provided wood screws.

Installation



Clean the glass with a damp cloth and dry it with a lint free dry cloth.

! NOTE: Ensure there are no debris or finger prints on the mirrored glass, or on the inner side of the front glass before you begin.

9 Media Arrangement

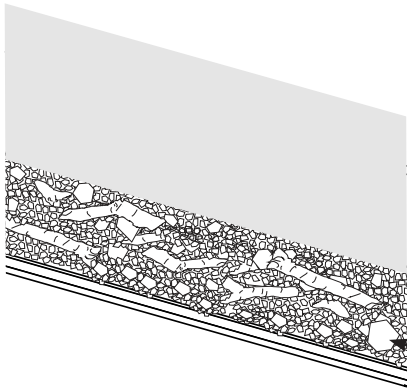

Place the magnetic timer cover over the manual controls.
Place the loose chips evenly across the front of the media bed.

Timer Cover Location

10 Install the Side Glass Panels and Front Glass

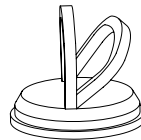

Suction Cup

! NOTE: The side glass panels are only applicable for VST130-III

! NOTE: Ensure the suction cups are securely attached to the glass.

Install both side glass panels first.

Using the suction cup to assist, install the side glass panels and front glass by inserting the top of the glass into the upper slot. Carefully tilt it toward the inside until it is in the vertical position. Once in place, gently drop it into the bottom slot.

11 Installation Finishing

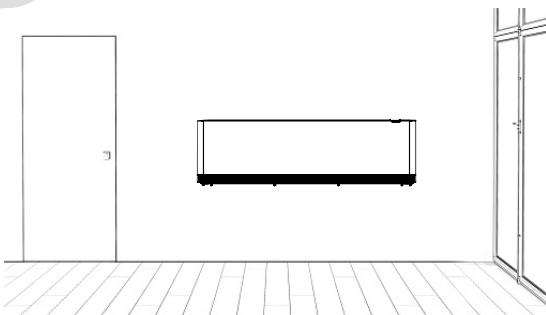

Finish the installation using the finishing materials of your choice.

! CAUTION: Do not drill into firebox housing.

! NOTE: The fireplace trim is designed to be installed with 1/2" (12.7mm) drywall. Other finishing materials are applicable.

Operation

⚠ WARNING: This electric firebox must be properly installed before it is used.

General Operation

The mains switch controls the electricity supply to the fireplace. The mains switch must be in the on (I) position for the fireplace to operate with or without heat.

The mains switch is located behind the front glass at the upper right corner. Remove the front glass to access the switch.

When the fireplace is powered on the media bed, and flame screen will light up. This action may take up to 7 seconds.

! NOTE: The flame screen resets for 2-3 seconds, every 30 minutes.

! NOTE: The fireplace will retain the previously used settings after a power interruption.

Timer

The Timer is located behind the mirrored glass, at the bottom right of the fireplace. The SD Card slot and the USB slot are located beside the timer on the media bed. It is recommended to complete the 7-day programming before the glass installation.

! NOTE: Ensure the timer cover is always tightly secured in place.

! NOTE: Program the Timer prior to installing the mirrored glass. If the Timer is not programmed for a 7 day operation it will remain in the “MAN ON” mode. Refer to the Timer Operation section (p. 14) for more information.



Remote Operation

The fireplace is supplied with a multifunction IR remote control.

! NOTE: To operate correctly, remove the plastic strip from the remote control, and point the remote control towards the front, right side of the fireplace.



Resetting the Temperature Cutoff Switch

Should the heater overheat, a manual limit cut-out will turn the unit off and it will not come back on without being reset. It can be reset by turning the unit off at the main disconnect panel and waiting 30 minutes before turning the unit back on.

⚠ CAUTION: If you need to continuously reset the heater, turn the unit off at the main disconnect panel and contact technical support.

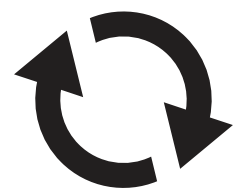

Operation

Icon Operations



Standby

Press  to turn on the unit or to put it in standby mode.
When the unit is turned back on, it will retain the previously used settings.



Volume Increase

Press  to increase the audio volume (fire sound).



Volume Decrease

Press  to decrease the audio volume (fire sound).



Log Bed Ambience Brightness

Press  to increase the brightness of the LED log bed.
The unit will 'beep' each time the button is pressed until it reaches maximum or minimum brightness.



Log Bed Ambience Dim

Press  to decrease the brightness of the LED log bed.
The unit will 'beep' each time the button is pressed until it reaches maximum or minimum brightness.



Heat ON

Press  to turn the heat on. This button toggles between half heat (900W) - indicated by 2 'beeps' and full heat (1800W) - indicated by 3 'beeps'.



Heat OFF

Press  to turn the heat off. When the heater is turned off the unit will 'beep' once. (The fan continues to run for approximately 10 seconds).



Temperature Increase

Press  to increase the temperature setting.



Temperature Decrease

Press  to decrease the temperature setting.

The temperature is adjustable from 15 to 30 and is displayed on the fireplace digital display.
The unit will 'beep' each time the remote control temperature buttons are pressed.

Operation

Timer Operation

! IMPORTANT: Remember to observe all safety warnings when operating the heater on auto setting, either attended or unattended.

The timer allows you to select 'AUTO' or 'MAN ON' by pressing the 'MODE' button until the required MODE appears at the bottom of the timer display.

'MAN OFF' MODE heat is permanently off. This is also the default screen.

'MAN ON' MODE allows power to the heater uninterrupted by the program settings.

'AUTO DLY' switches the heater ON and OFF every day according to a set daily program.

'AUTO BLK' switches the heater ON and OFF according to a set of programs for weekdays only or weekends only.

Initial Operation

In the event of a power cut or disconnection from the mains, the timer will continue to function and all programmed settings will be retained for up to six months providing the timer batteries are fully charged.

If however the timer batteries have not been charged fully, or if the heater is deprived of power for longer than six months, then the time and programme settings are likely to be lost and you may therefore need to reset the time and programme before using the 'AUTO' MODE again. For initial use, plug the heater into a regular household power point and turn the power on. The timer is now ready to be set up for use.

! NOTE: Timer Memory Back Up Batteries – Once the heater has been left plugged in with the socket switched on for at least 72 hours the timer's memory back up batteries will be fully charged.

Setting the Time

1. Hold the 'PROGRAM' button until the clock symbol appears on the screen and the hour digit flashes. The user can now set the clock.
2. To adjust the hour use the '-' & '+' buttons. Confirm the hour digit by pressing 'ENTER'.
3. Once 'ENTER' has been pressed the minutes will flash. To adjust the minutes use the '-' & '+' buttons. Confirm the minute digit by pressing 'ENTER'.
4. The timer now returns to the default display.
5. To reset incorrect time, repeat previous steps. Once the correct time is set, a total of four ON/OFF time programs can be set for operation.

Setting Programmes

OPTION 1; Daily ('DLY' on display): This is a daily program function, Monday to Sunday with four ON/OFF program options available.

OPTION 2; Block ('BLK' on display): This is a block program function, Monday to Friday with four ON/OFF program options or Saturday to Sunday with four ON/OFF program options.

Press the 'PROGRAM' key to set the programs starting with 'Daily ON' P1.

Setting P1 On Time

1. To set the hour use the '-' & '+' buttons. Confirm the hour digit by pressing 'ENTER'
2. To set the minutes use the '-' & '+' buttons. Confirm the minute digit by pressing 'ENTER'.

! NOTE: The minutes can only be set in 10 minute blocks.

Setting P1 Off Time

1. To set the hour use the '-' and '+' buttons. confirm the hour digit by pressing 'ENTER'.
2. To set the minutes use the '-' & '+' buttons. Confirm the minute digit by pressing 'ENTER'.

Repeat steps 1 to 4 to programme P2, P3 and P4. After programming P4 you automatically enter the BLOCK programme option. Repeat steps 1 to 4 to programme P2, P3 and P4. After programming P4 you automatically exit the BLOCK programme option. At any time while programming the timer you can press the PROGRAM button to exit to the default display.

! NOTE: You can cycle quickly from daily mode to block modes by pressing the MODE button.

The Advance Function

When in AUTO MODE, if the '+' button is pressed for longer than 2 seconds the programme will ADVANCE to the next setting programmed and will only revert back to the program when the subsequent programme time is reached. When the ADVANCE function is running the ADVANCE segment will be displayed on the LCD screen. If the '-' button is pressed for longer than 2 seconds when the ADVANCE programme is running the ADVANCE feature will automatically be cancelled and the programme will run as normal.

e.g. If the present time is 14:00 and P1 ON is at 17:00 and P1 OFF is 19:00, if '+' is held for 2 seconds and remains on until 19:00. ADVANCE disappears from the screen at 17:00 as set program is then running.

Key Lock

To lock the keypad press ENTER and MODE simultaneously. The key symbol will appear on the screen when the keypad is locked. To unlock the keypad repeat the action above.

Maintenance

Remote Control Battery Replacement

To replace the battery:

1. Remove battery cover of the remote control using a Philips screwdriver.
2. Correctly install one 3 Volt (CR2032 [longer life] or CR2025) battery in the battery holder with the + side facing up.
3. Secure the battery cover using the previously removed screw.

Battery must be recycled or disposed of properly. Check with your Local Authority or Retailer for recycling advice in your area.



⚠ WARNING: Disconnect power and allow heater to cool before attempting any maintenance or cleaning to reduce the risk of fire, electric shock or damage to persons.

Flame Screen Cleaning

The flame screen is cleaned in the factory during the assembly operation. During shipment, installation, handling, etc., the flame screen may collect dust particles; these can be removed by dusting lightly with a clean, soft, lint-free, dry cloth.

To remove fingerprints or other marks, the flame screen can be cleaned with a clean, soft, lint-free, dry cloth, and a fast-drying household glass cleaning solution with ammonia (1.5% weight maximum) or water. The partially reflective glass should be completely dried with a soft lint-free cloth to prevent water spots. To prevent scratching, do not use abrasive cleaners.

! NOTE: Never use abrasive detergents and/or hydrofluoric and phosphoric acids.

! NOTE: Never attempt to remove debris or dirt by using a scraper, razor blade or any other sharp tool.

! NOTE: Do not allow water or cleaning solutions to dry on the glass.



Fireplace Surface Cleaning

Use only a damp cloth to clean painted surfaces of the fireplace. Do not use abrasive cleaners.

The fireplace should not be operated with an accumulation of dust or dirt on or in the unit, as this can cause a build-up of heat and eventual damage. For this reason the heater must be inspected regularly, depending upon conditions and at a minimum yearly intervals.

Servicing

Except for installation and cleaning described in this manual, an authorized service representative should perform any other servicing.



Troubleshooting

For more troubleshooting, consult the Service Manual.

Problem	Cause	Solution
Fireplace does not turn on	No incoming power	Ensure unit is receiving power Check socket switch is on Ensure mains switch is on
	The batteries in the remote control are dead or installed incorrectly	Replace remote control battery
	Timer Control is turned off or in Program Mode	Check the status of the Timer Control. Ensure it is On and in Manual Mode.
Heater does not turn on	Set Temperature is too low	Increase the heater temperature.
Flame Screen is blank	Improper circuit current rating	Switch the unit to standby, and switch it back on. The flame picture should resume after approximately 7 seconds.
	SD Card	Ensure the SD Card is inserted correctly.

RECYCLING



At the end of the electrical products useful life it should not be disposed of with household waste. Please recycle where facilities exist. Check with your Local Authority or retailer for recycling advice in your area.

© Glen Dimplex Heating and Ventilation. All rights reserved. Material contained in this publication may not be reproduced in whole or in part, without prior permission in writing of Glen Dimplex Heating and Ventilation.