

Owners &  
Installation

# Manual



## Chazelles HP800

**PLEASE KEEP THESE INSTRUCTIONS FOR  
FUTURE REFERENCE**

**WARNING:**

Improper installation, adjustment, alteration, service or maintenance can cause injury or property damage. Refer to this manual. For assistance or additional information consult an authorised installer.





# TABLE OF CONTENTS

## IMPORTANT

Please read this manual before installing and operating the Chazelles Fireplace. Failure to follow these instructions may lead to a possible fire hazard and will void the warranty. Fireplace is to be installed by a qualified licensed installer.

### General Information

Safety Note .....	2
Safety Precautions .....	3
Specifications .....	4

### Internal Deflectors and Vermiculite Panels

Assembly Instructions .....	5
-----------------------------	---

### Fireplace and Flue System Installation

Before Installing Your Fireplace .....	6
Standard Installation .....	7
Deflector Installation .....	7
Typical In-Built Masonry Installation .....	8
Air Supply and Ventilation .....	9
Access Panel .....	9
Flue System Installation .....	10
Flue Penetration .....	11

### Operating Instructions

Controls .....	12
Before Using Your Chazelles Fireplace .....	13
Starting Your Fire .....	13
Creosote - Formation and Need For Removal .....	14
Controlling Your Fire .....	14
Restarting Your Fire .....	15
Hints For Burning .....	16
Selecting Wood .....	16
Safety Rules .....	17

### Maintenance

Removing The Ashes .....	18
Cleaning The Window .....	18
Cleaning Of Flue .....	19
End Of Season Cleaning .....	19
Cleaning the Air Guide .....	19

### Trouble Shooting

Problem And Possible Cause .....	20
Problem And Possible Cause .....	21

### Chazelles Warranty Policy

Period Of Cover .....	23
Warranty Exclusions .....	23
Warranty Claims .....	24



## GENERAL INFORMATION

### Thank you for purchasing a **CHAZELLES FIREPLACE PRODUCT**

The Chazelles Wood Burning Central Heating Fireplace is designed to heat your house through Radiant and Convection Heat. The fireplace is designed to burn hardwood only. This appliance requires a flue and must be installed into a non combustible cavity by a Qualified Licensed Installer.

#### **SAFETY NOTE**

If this wood fireplace is not properly installed, a house fire may result. For your safety, follow the installation instructions, building codes, or authority having jurisdiction about restrictions and installation requirements.

#### **DO NOT BURN (WILL VOID WARRANTY):**

- Treated Wood
- Cardboard
- Tea Tree
- Solvents
- Oil Based Woods
- Coloured Paper
- Coal
- Garbage
- Unseasoned Wood

# ! WARNING



**HOT GLASS WILL CAUSE BURNS.**

**DO NOT TOUCH GLASS UNTIL COOLED.**

**NEVER ALLOW CHILDREN TO TOUCH GLASS.**

# ! WARNING

**ONLY CLEAN APPLIANCE WITH A DAMP CLOTH.**  
**(NEVER WHEN UNIT IS HOT).**

**DO NOT USE ANY ABRASIVE CLEANERS.**

# GENERAL INFORMATION

## SAFETY PRECAUTIONS



This appliance is designed and approved for the burning of **hardwood only**. Do not attempt to burn any other type of fuel other than hardwood in this appliance, it will void all warranties and safety listings.



Gasoline or other flammable liquids must never be used to start the fire or "Freshen Up" the fire. Do not store or use gasoline or other flammable liquids in the vicinity of this appliance.



Do not touch the appliance while it is hot and educate all children of the danger of a high temperature appliance. Young children should be supervised when they are in the same room as the appliance at all times.



Ashes must be disposed in a metal container with a tight lid and placed on a non-combustible surface well away from the home or structure.



This appliance must be properly installed to prevent the possibility of a house fire. The instructions must be strictly adhered to. Do not use makeshift methods or compromise in the installation.

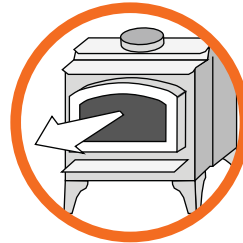

Keep items of furniture, drapes, curtains, wood, paper and other combustibles away from the front of the appliance at a minimum distance of 1.5 metres.



Never try to repair or replace any part of this appliance unless instructions are given in this manual. All other work must be done by a trained technician.

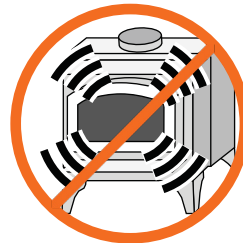

Overfiring the appliance may cause a house fire and damage the fireplace.

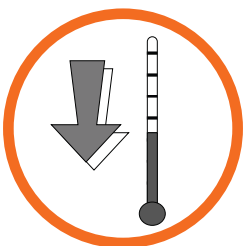

Allow the appliance to cool before carrying out any maintenance or cleaning.



Do not make any changes or make any modifications to an existing masonry fireplace or chimney to install this appliance. Do not make any changes to the appliance to increase combustion air.

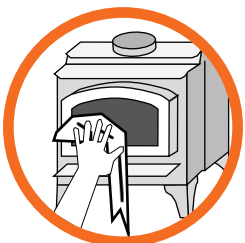

Maintain the door and glass seal and keep them in good condition. Do not operate this heater with broken or missing glass. Avoid placing wood against the glass when loading. Do not slam the door or strike the glass.



Do not throw this manual away. It has important operating and maintenance instructions that you will need at a later time. Always follow the instructions listed in this manual.

# GENERAL INFORMATION

## SPECIFICATIONS HP800

	<b>Cheminées de Chazelles</b>	
		<b>DESIGN HP800</b>

# INTERNAL DEFLECTORS AND VERMICULITE PANELS

## ASSEMBLY INSTRUCTIONS

- 1 Install top black deflector plate (A) to the top area of the fireplace. Please note, the cut out in top deflector plate is off centre, the rectangular cut out in the deflector must be placed towards the rear of fireplace as pictured. Make sure protruding edge is facing downwards into fireplace.



- 2 The top deflector plate is to be positioned on top of the 4 bolts screwed into the top of the fireplace (refer to picture attached). From inside the fireplace, screw out the **rear** bolts approx. 20mm to support the deflector plate. This will also allow easy removal & maintenance of the fireplace.



- 3 Fit both Left and Right side (B & C) vermiculite panels as required. NOTE – VERMICULITE PANELS ARE VERY FRAGILE AND CAUTION MUST BE EXERCISED AT ALL TIMES WHILE HANDLE AND LOADING THE FIREPLACE. The Right side vermiculite panel (C) has a semi-circle cut out at the top front section for the internal deflector shaft.

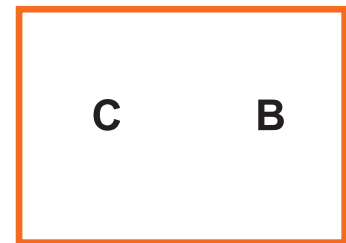

- 4 Fit rear vermiculite panels, 2 small panels (D) on the outer edges of the fireplace, centre panel (E) with the air intake holes in the centre as pictured. Flat smooth surface to face the internal area of the fireplace. Tapered edge on the vermiculite panels must be placed at the top when installing.



- 5 Carefully fit top silver draft shutter plate (F). Firstly position the plate front arms on top of the front internal deflector into the locating pins. Make sure centre 'V' section of the silver draft shutter is facing towards the bottom of fireplace. Rear section of the plate is to be located on top of the rear vermiculite panels. This also supports and secures the rear vermiculite panels.

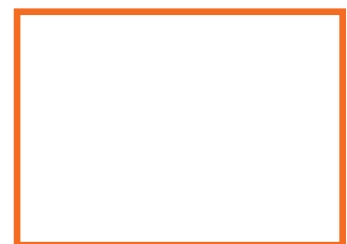

# FIREPLACE and FLUE SYSTEM INSTALLATION

## TO BE INSTALLED BY A QUALIFIED AND LICENSED INSTALLER

Chazelles Fireplaces are constructed with the highest quality materials and assembled under strict quality control procedures that ensure years of trouble free and reliable performance.

It is important that you read this manual thoroughly and fully understand the safe installation and operating procedures. The more you understand the way your Chazelles Fireplace operates, the more enjoyment you will experience from knowing that your unit is operating at peak performance.

Heating capacity will vary depending on the home's floor plan, degree of insulation, and the outside temperature. It is also affected by the quality and moisture level of the fuel.

## BEFORE INSTALLING YOUR FIREPLACE

Please read this entire manual before you install and use your new wood fireplace. Failure to follow instructions may result in property damage, bodily injury or even death. Install and use only in accordance with manufacturer's installation and operating instructions.

**WARNING: Careless installation is the major cause of safety hazard. Check all local building and safety codes before installation of unit.**

## IMPORTANT NOTES

**It is the installers responsibility to carefully check the deflector control and lateral operation of the door several times before enclosing the firebox.**

The Chazelles fireplace must be installed by a qualified person. Fireplace must be installed into a fully non combustible fireplace construction on all surfaces surrounding the fireplace, from floor to ceiling, eg top, bottom, sides, back. Materials to be used can be brick, concrete, masonry blocks, hebel blocks/panels, compressed fibro, promat.

**DO NOT USE TIMBER FRAMING, USE METAL FRAMING WHEN NECESSARY.**

The flooring must have adequate weight-bearing capacity. It must be level and incombustible. Fireplace must sit level on a solid concrete hearth. Timber floors may require additional reinforcement.

**The fireplace is not designed to support any structure or framing.**

Allow a minimum 3 to 5mm clearance between the firebox and the finished fireplace opening to allow for expansion.

Thermal insulation (fire rock rockwool) shall be heat resistant with aluminium foil adhered to one face. Minimum thermal resistance of 0.7m<sup>2</sup>.k/w at 50 degrees Celsius (or of 0.4m<sup>2</sup>.k/w at 200 degrees Celsius) classed as A1 or at least M0 or A2-s1. ( Equivalent to 30mm of fibrous insulator of a density less than 100 kg/m<sup>3</sup> with aluminium foil or self supporting high temperature structural insulators made of calcium silicate) Aluminium foil should always be on heat side. Fire rock Rockwool will cover back, front & sides of the fireplace structure from base to ceiling. Thermal insulation is absolutely essential in the case of light structure. However, in all cases the insulation is recommended in order to avoid heat loss.

# FIREPLACE and FLUE SYSTEM INSTALLATION

## STANDARD INSTALLATION - Please read instructions before assembly

- 1 Make sure door is closed when moving and transporting fireplace.
- 2 The fireplace air intake is located underneath the fireplace and **MUST NOT** be obstructed and allow air flow into fireplace. The fireplace must be supported and raised from the non combustible floor with bricks / non combustible material.
- 3 Inspect, check and operate door and air damper controls.
- 4 Confirm all fireplace clearances are as specified by the manufacturer.
- 5 Install flue system. The performance of your wood fireplace is governed to a very large part by the flue system. Do not connect flue to another flue serving another appliance.
- 6 Avoid using 45 degree flue bend straight off top of fireplace. The recommended minimum length is 800mm.



**THE APPLIANCE AND FLUE-SYSTEM SHALL BE INSTALLED IN ACCORDANCE WITH AS/NZS 2918:2001 AND THE APPROPRIATE REQUIREMENTS OF THE RELEVANT BUILDING CODE OR CODES. APPLIANCES INSTALLED IN ACCORDANCE WITH THIS STANDARD SHALL COMPLY WITH THE REQUIREMENTS OF AS/NZS 4013 WHERE REQUIRED BY THE REGULATORY AUTHORITY. ANY MODIFICATION OF THE APPLIANCE THAT HAS NOT BEEN APPROVED IN WRITING BY THE TESTING AUTHORITY IS CONSIDERED TO BE IN BREACH OF THE APPROVAL GRANTED FOR COMPLIANCE WITH AS/NZS 4013.**

**CAUTION: MIXING OF APPLIANCE OR FLUE-SYSTEM COMPONENTS FROM DIFFERENT SOURCES OR MODIFYING THE DIMENSIONAL SPECIFICATION OF COMPONENTS MAY RESULT IN HAZARDOUS CONDITIONS. WHERE SUCH ACTION IS CONSIDERED, THE MANUFACTURER SHOULD BE CONSULTED IN THE FIRST INSTANCE.**

## DEFLECTOR INSTALLATION

The deflector shall be Firerock Rockwool rigid bats or metal sheet 20 gauge minimum with Firerock Rockwool 30mm on top or Hebel power panels 75mm with Firerock Rockwool on top or Compress Fibro minimum 20mm with Firerock Rockwool secured underneath.

## IMPORTANT:

**Seal around the perimeter of the deflector & around the S/Steel flue with fireproof silicone or casting plaster and hemp. This will prevent the loss of convective heat through the deflector.**



# FIREPLACE and FLUE SYSTEM INSTALLATION

## TYPICAL IN-BUILT MASONRY INSTALLATION



### HP800

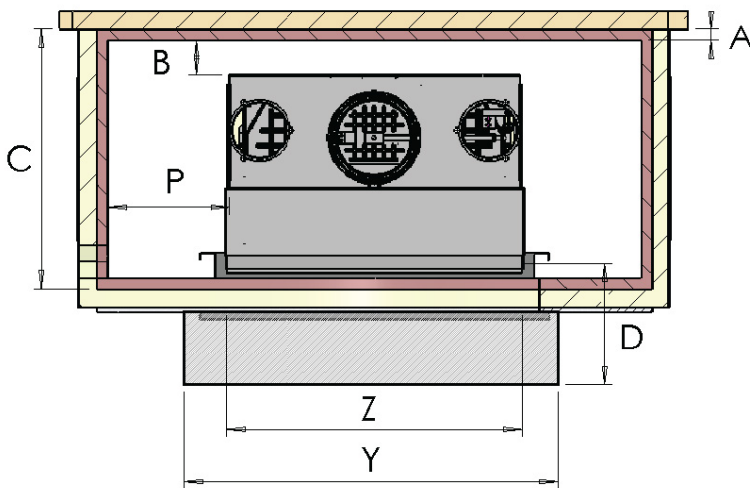
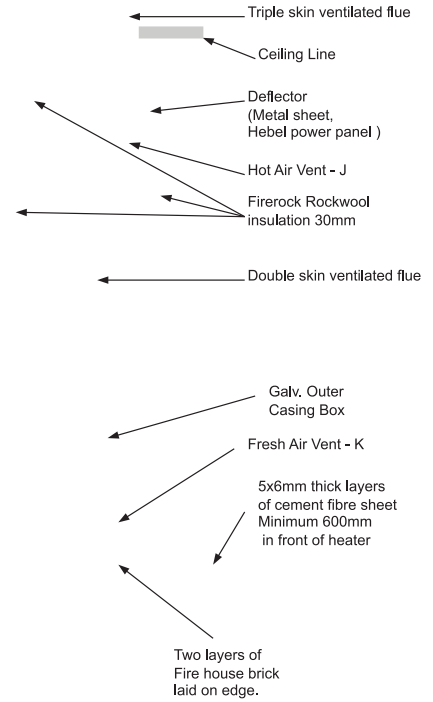
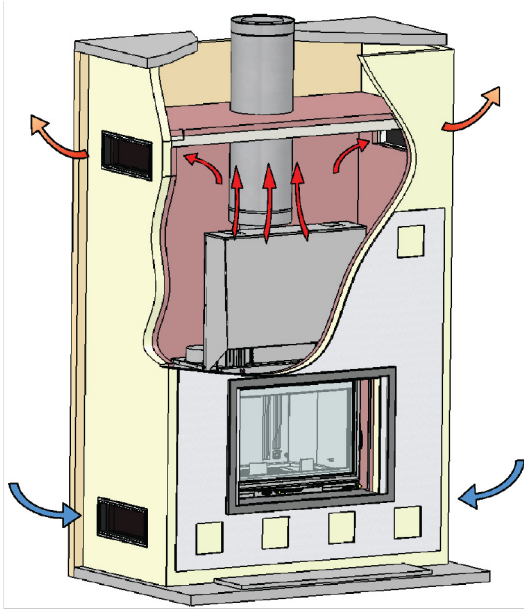

	HP800
A	30
B *	125
C *	628
D *	600
E *	75
F *	620
G *	150
H *	150
I *	1800
J *	2x350cm <sup>2</sup>
K*	2x350cm <sup>2</sup>
L	∅ 230
M	∅ 330
P*	100
Y*	1100
Z*	800

\* Minimum sizes.  
 Sizes are in mm unless specified.

THE APPLIANCE AND FLUE-SYSTEM MUST BE INSTALLED IN ACCORDANCE WITH THE REQUIREMENTS OF AS/NZ 2918-2001 AND THE APPROPRIATE REQUIREMENTS OF THE RELEVANT BUILDING CODE OF AUSTRALIA. IN ALL CASES AS/NZS 2918 SHOULD BE REFERRED TO FOR CONFIRMATION OF ANY INSTALLATION REQUIREMENTS.

**TO BE INSTALLED BY A QUALIFIED LICENSED INSTALLER**

## AIR SUPPLY AND VENTILATION

Our products have very high output power and must be installed as per manufacturer instructions. Failing to provide air input around the base level of the fireplace and out air output on top will prevent our product to work efficiently, will damage the unit and will void the warranty.

## FRESH AIR SUPPLY (LOWER VENTS)

Fresh air supply at the base level on sides, front or underneath the unit pending on the installation and design of the fireplace surround.

Total minimum section for the vent(s) 700 cm<sup>2</sup> in 1 or more vents. Bigger section will be better.

## HOT AIR OUTLETS (UPPER VENTS)

Same size grate(s) or vent(s) should be used on top front or side of the fireplace structure **JUST BELOW** the internal deflector. Total minimum section for the vent(s) 700 cm<sup>2</sup> in 1 or more vents.

## ACCESS PANEL

When possible it is recommended to install an access/service panel on side/ front or back of the fireplace structure to allow any maintenance inside the fireplace cavity.

# FIREPLACE and FLUE SYSTEM INSTALLATION

## FLUE SYSTEM INSTALLATION

Single skin flue in S/Steel (minimum 0.5 mm thickness) shall only be used when the fireplace and chimney structure continue above the roof. Crimped end down.

Triple skin flues (Modular air flow) shall be used when the fireplace structure terminates at ceiling level (read “ Flue Penetration “). Crimped end up.

### FLUE PENETRATION

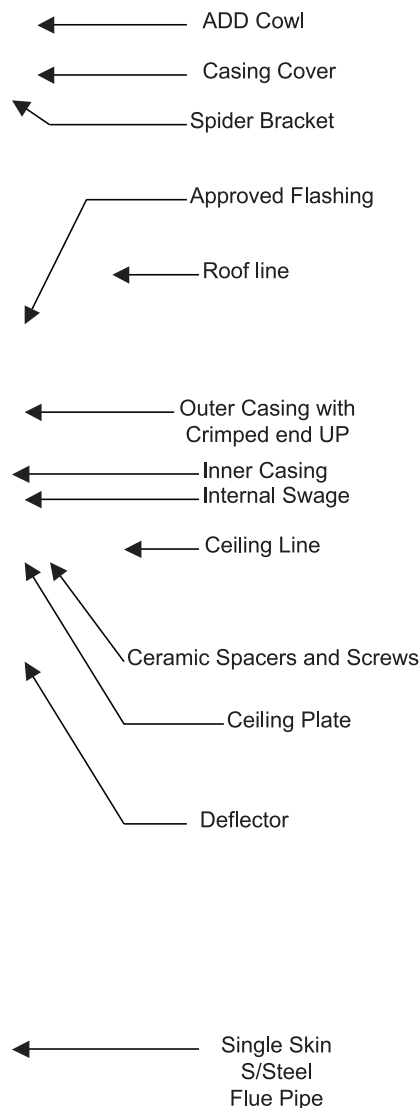

#### IMPORTANT

THIS DRAWING IS MEANT A GUIDE HEATERS SHOULD BE INSTALLED BY A QUALIFIED PERSON.

#### INSTALLATION INSTRUCTIONS

- 1 READ BROCHURE AND POSITION STOVE
- 2 MARK CIRCLE ON CEILING
- 3 CUT AWAY CEILING USING A SHARP KNIFE TO SCORE SURFACE FIRST THEN USE A KEYHOLE SAW OR JIG SAW TO FINISH OUT.
- 4 BEFORE CUTTING CEILING TRY TO DETERMINE POSITIONS OF NOGGINS TO AVOID CUTTING.
- 5 DRILL 3/16 HOLE IN SUPPORT ANGLES AND CEILING CAP. POSITION THE HOLE SO THAT THE CEILING CAP WILL PROTRUDE A MINIMUM OF 150 MM BELOW THE CEILING.
- 6 PLACE CEILING CAP UNIT IN CENTRE OF HOLE MAKING SURE IT IS 40 MM FROM COMBUSTIBLES AND FIX SUPPORT ANGLES TO NOGGIN WITH NAILS OR SCREWS.
- 7 ADD CEILING COLLAR ( SPLIT RING ) AGAINST CEILING CAP COLLAR IS USED FOR FLAT OR SLOPED. CEILING BY PULLING TIGHT AS POSSIBLE AND FIX WITH POP RIVET. POP CEILING COLLAR 12 MM FROM CEILING LINE.
- 8 PLACE MID LOCATING RING INTO CEILING CAP.
- 9 FEED S/ST THROUGH LOCATING RING PLACE COVER CONE & COWL. FIX WITH POP RIVETS.

**\* Minimum Sizes**  
**Minimum Flue Length: 4.0 Metres**

# FIREPLACE and FLUE SYSTEM INSTALLATION

## FLUE PENETRATION

### FLUE PENETRATION

AS/NZS2918-2001

Un-tested flue with sloped ceiling penetration greater than 30° from horizontal.

4.5.1(b)=50mm clearance to combustible material

A=50mm for 200mm Ø flue pipe

A=62.5mm for 225mm Ø flue pipe

4.6.3(b)

Downward distance of casing and 3xØ flue distance of the ceiling plate

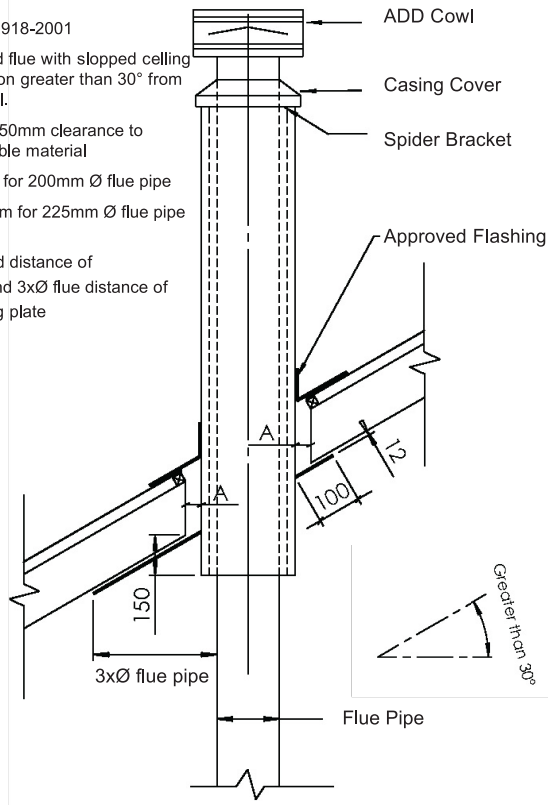

AS/NZS2918-2001

Un-tested flue with sloped ceiling penetration greater than 30° from horizontal.

4.5.1(b)=50mm clearance to combustible material

A=50mm for 200mm Ø flue pipe

A=62.5mm for 225mm Ø flue pipe

4.6.3(b)

3xØ flue from active flue to heat sensitive surface

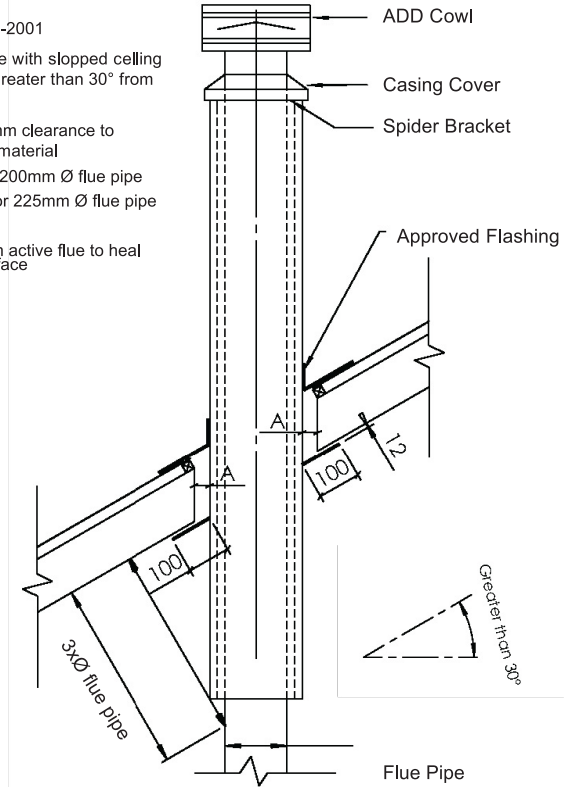

### MINIMUM HEIGHT OF FLUE SYSTEM EXIT

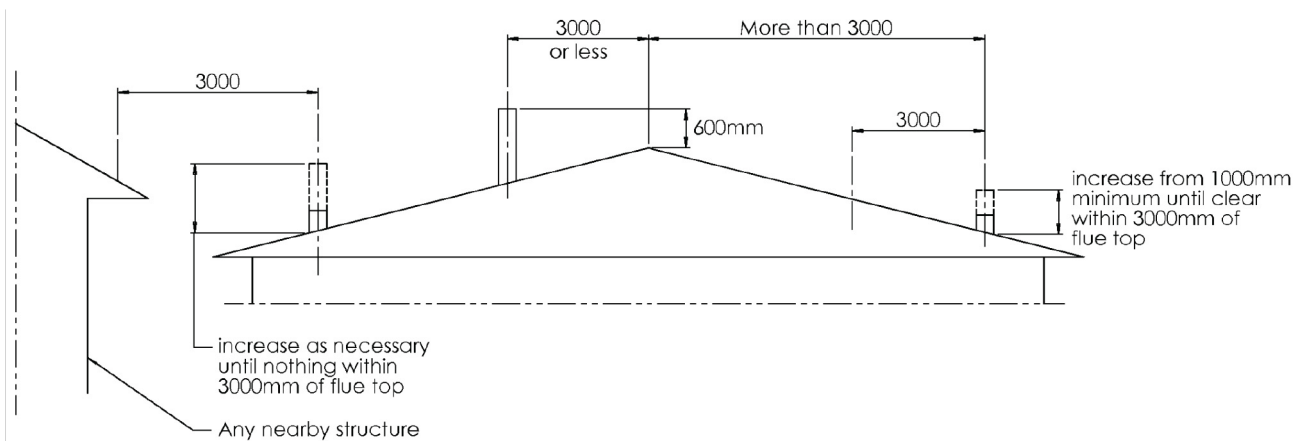

# OPERATING INSTRUCTIONS

**THE MAXIMUM HARDWOOD LOADING CHARGE MUST NOT EXCEED 9KG FOR HP800. OVERLOADING WILL DAMAGE SOME FIREBOX COMPONENTS AND WILL VOID THE WARRANTY.**

Use very dry wood (15% humidity maximum) with 2 years covered storage after cutting in order to obtain the best efficiency and avoid rapid stains on the window. We strongly advise you to comply with the product specifications in order to ensure a maximum lifespan.

**The performance of your wood fire is governed to a very large part by the flue system.** Too short a flue can cause difficult start-up, dirty glass, backsmoking when door is open, and even reduced heat output. Too tall a flue may prompt excessive draft which can result in very short burn times and excessive heat output which may damage the fireplace.

## CONTROLS

### **Controls (depending on version of product)**

Accessories are at your disposal - use them to avoid getting burnt!



The two “cool hand” tools necessary for damper control and adjusting the primary air grate.



Glove (supplied)

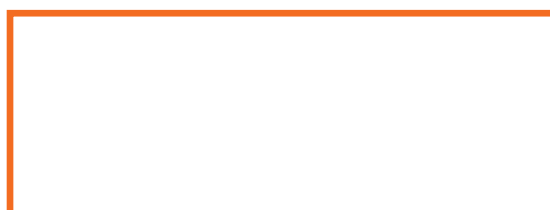

The scraper (supplied depending on model): for removing ashes and cleaning the appliance.

# OPERATING INSTRUCTIONS

## BEFORE USING YOUR CHAZELLES FIREPLACE

Although your fireplace may appear to have dried out, it is essential to wait 3 to 4 weeks after completing installation to ensure the moisture evaporates from all parts (connections, flue, stone covering, hood, etc) before lighting your first fire.

Once this has passed, it is recommended you lite your first fire with a moderate amount of wood and a reduce opening of the air intake to limit the intensity of the fire and for a maximum 3 hours. This will allow a progressive rise in temperature with the fireplace and other elements, to avoid rapid expansion of the materials and thermal shock. This is recommended for the first 10 fires to finalise the drying process.

During initial use, there may be an unpleasant smell from the unit, caused by surplus paint. Please ventilate the room as the smell will disappear after a few fires.

## STARTING YOUR FIRE - (hardwood timber is only to be used)

1. Open the door.
2. Pull the Primary & Secondary Air Damper Control to max (outwards).

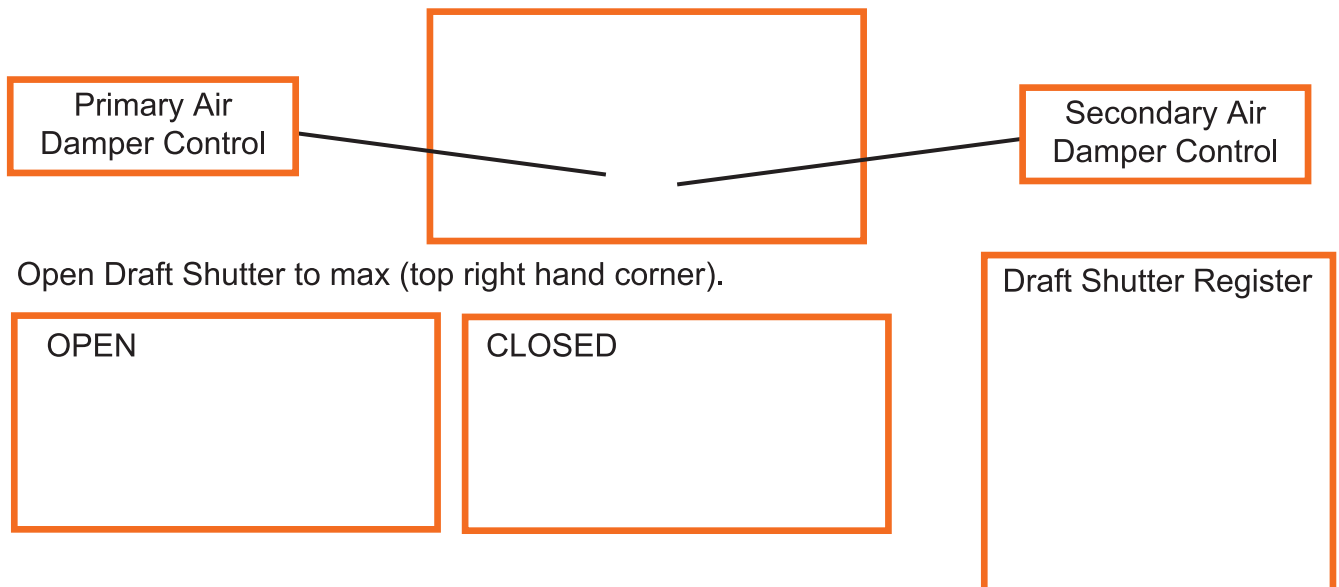

3. Open Draft Shutter to max (top right hand corner).

4. Make sure the movable primary air supply grate is pushed back to the rear of the fireplace and no ash is obstructing the air inlet holes.
5. Place firelighter on the base of the fireplace.
6. Place small twigs and then small branches no larger than 3 cm in diameter.
7. Ignite the firelighter.
8. Close the door.

Once the fire is well alight, open the door and add larger pieces of wood. Do not add too many pieces of wood as this will suffocate the fire. Observe the maximum loading charge for this appliance.

Use the air intake control dampers to achieve your desired power.

### **NOTE** – if model is fitted with draft shutter

If the fireplace door is closed and you wish to reload, it is important to fully open the draft shutter then open the door 20mm approx for a little while to allow the draught to increase in the fireplace and then slowly open the door fully. This will minimise smoke or ash particles entering the room.

To ensure maximum performance for your fireplace, it is always recommended to keep a close eye on it. The upper lever above the door on the right hand side operates the draft shutter.

The purpose of the draft shutter regulating mechanism is to regulate draft. Its different settings act upon smoke output, enabling selection of fire intensity and level of power desired.

# OPERATING INSTRUCTIONS

## CREOSOTE - FORMATION AND NEED FOR REMOVAL

When wood is burned slowly, it produces tar and other organic vapours, which combine with expelled moisture to form creosote. The creosote vapours condense in the relatively cool chimney flue of a slow-burning fire. As a result, creosote residue accumulates on the flue lining. When ignited, this creosote makes an extremely hot fire. The chimney and chimney connector should be inspected at least once every two months during the heating season to determine if a creosote buildup has occurred. If creosote has accumulated, it should be removed to reduce the risk of a chimney fire.



If you are not certain of creosote inspection, contact your local chimney sweeper for a full inspection. Excess creosote buildup may cause a chimney fire, that may result in property damage, injury, or death.



Operating this appliance continually at a low burn rate (air starvation) or using green (un-seasoned) wood will increase the formation of creosote.

## CONTROLLING YOUR FIRE

The desired heat is obtained by controlling the air intake and damper and selecting a wood load in line with your needs.

### For maximum heating

Load the appliance with 3 logs with diameters approx 10cm.

Primary air damper fully closed (pushed inwards) and the secondary air damper fully open. Top draft in open position (max). Only use this brightness temporarily, to raise the temperature of the premises after prolonged used.



### For less intense heat

Use a lesser load, 1 to 2 logs.

Move primary and secondary dampers to mid position.



### For normal operation

Close primary damper, open secondary damper and close top draft shutter to achieve maximum efficiency. You may further control the fire using the secondary air damper to achieve your desired power output.

### For longer period heating

With low brightness, use 1 or 2 unsplit logs on a bed of almost dead embers. Primary damper fully open and adjust secondary damper according to drawing conditions.



# OPERATING INSTRUCTIONS

## RESTARTING YOUR FIRE

For rapid lighting, restart the fire using the wood slivers: load the appliance, leaving the door slightly ajar for a few minutes if you wish to speed up the procedure, and keeping a watch on things; then reclose the door and work the controls. This helps to speed up restarting, especially when the wood is damp.



Work the removable primary air grate to remove ash and facilitate renewed combustion.

- Make changes in brightness (from low to normal, for example) before reloading, while embers are burning, to allow the appliance and the flue to modify operation progressively.

Continuous operation at low brightness, especially during the periods of mild, weather (unfavourable draft) and using damp wood, leads to incomplete combustion, which helps to cause deposits of bistrage and tar.

**Please be careful when reloading fireplace as vermiculite panels are fragile**

# OPERATING INSTRUCTIONS

**NOTE:** DO NOT OPERATE THE FIREPLACE **ALL THE TIME** WITH THE DOOR SLIGHTLY OPEN UP. WITH THE DOOR UP A FEW CENTIMETRES WILL HELP START THE FIRE MORE QUICKLY AND INCREASE THE COMBUSTION, BUT WILL DAMAGE THE CERAMIC ROPE AND DOOR FRAME BY OVER HEATING IF OPERATED THIS WAY ALL THE TIME.



**Never** use gasoline, gasoline-type lantern fuel, kerosene, charcoal lighter fluid, or similar liquids to start or "freshen up" a fire in this stove. Keep all such liquids well away from the stove while it is in use.



DO NOT USE CHEMICALS OR FLUIDS TO START THE FIRE. DO NOT BURN GARBAGE OR FLAMMABLE FLUIDS SUCH AS GASOLINE, NAPHTHA OR ENGINE OIL. Do not place such fuel within space heater installation clearances or with in the space required for charging and ash removal.



If using a firestarter, use only products specifically designed for stoves - follow the manufacturer's instructions carefully.



**HOT WHILE IN OPERATION. KEEP CHILDREN, CLOTHING AND FURNITURE AWAY. CONTACT MAY CAUSE SKIN BURNS.**

## Starting a "Top-Down Fire"

One particularly successful method for starting a fire is to stack several large pieces of wood in the centre of the fireplace (see the illustration to the right). Then place several wads of newspaper and firestarter in the centre with kindling on top. When you light the newspaper this "top-down" fire will burn its way to the centre, igniting the larger pieces. With some practice, this method should work for you.

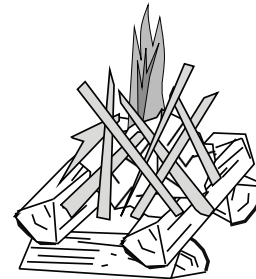

## HINTS FOR BURNING

- Get the appliance hot before adjusting to low burn.
- Use smaller pieces of wood during start-up and high burns to increase temperature.
- Use larger pieces of wood for overnight or sustained burns.
- Stack the wood tightly together to establish a longer burn.
- Be considerate of neighbours & the environment: burn dry wood only.

## SELECTING WOOD

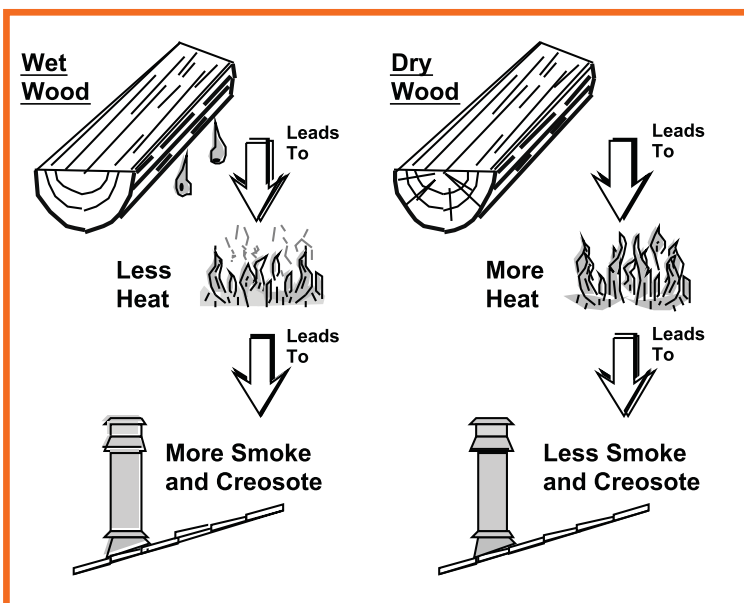

- Dry wood is the key.
- Dry wood burns hot, emits less smoke and creates less creosote.
- Testing wood moisture.
- Split wood stored in a dry area will be fully dry within a year. This ensures dry wood. If purchasing wood for immediate use, test the wood with a moisture meter. Some experienced wood burners can measure wood moisture by knocking pieces together and listening for a clear "knock" and not a "thud".

# OPERATING INSTRUCTIONS

The heat output from the Chazelles fireplace will depend on the type of timber being used and moisture content in the timber.

## For your reference

Hardwood timber logs 50cm long

- 6 cm weighs approx 1 kg
- 10 cm weighs approx 3 kg
- 15 cm weighs approx 7 kg

**CAUTION: IN THE EVENT OF A CHIMNEY FIRE, CLOSE THE AIR INLETS, DOOR, AND WINDOWS AND CALL FIRE BRIGADE.**

## SAFETY RULES

### General Points

1. Never try to put out a fire by throwing water on it.
2. The window and certain other parts of the appliance get very hot. "Watch out for risk of getting burnt - especially as far as children are concerned".

**The fireplace radiates a lot of heat through the window glass. Do not place any heat sensitive materials or objects closer than 1.5 metres from glass.**

**Minimum  
1.5 metres  
from glass**

## 1. REMOVING THE ASHES

The air required for combustion of wood arrives beneath the grille when the primary air damper is open, and also keeps the grille cool. In order to obtain optimal performance and avoid degradation of the grille due to overheating, it is therefore essential to prevent its obstruction by regularly removing ashes.

- Use scraper to remove ash from around grille.
- Empty the ash from ashtray into a metal or non flammable container.
- It is recommended to remove the inside air lower air grille and clean/vacuum if necessary, or on a regular basis to maintain peak performance.

## 2. CLEANING THE WINDOW

- Burning unseasoned wood or lower burn rates leads to dirtier glass.
- Do not clean glass with abrasive cleaners, allow the fireplace to fully cool down before cleaning.
- Apply Chazelles Window Gel Cleaner to the inside of glass (Available from Sydney Head Office). Wipe with a paper towel and clean glass.

**GEL GLASS CLEANER 500 ML. BEST WAY  
TO CLEAN YOUR VITRO CERAMIC GLASS  
AND REMOVE THE STAINS IN SECONDS!**

**CONTACT OUR HEAD OFFICE CHAZELLES  
IN SYDNEY TO ORDER.**

## 3. CLEANING OF FLUE

- mechanical cleaning of the flue is essential. It should be carried out at least twice a year by a professional, with at least one sweeping during the heating season.
- Thoroughly check the state of the appliance, elements ensuring air tightness in particular the joints and closing mechanisms, etc
- If there are any defects, the fire place must not be used until it has been rectified.

## 4. END OF SEASON CLEANING

- Clean the appliance with a brush and vacuum cleaner.
- During the warm season when fireplace is not being used, it is recommended the air inlets be left open to allow air circulation. Particularly with fireplaces which have not been used for a continuous period (eg holiday homes). Sporadic use perpetuates condensation which accelerates oxidation.
- Clean and lubricate all hinges, bearings and rails before winter season starts and when season ends.
- Check all hinge screws and bolts for tightness as they may become loose over time.

It is very important that the flue is swept and cleaned to reduce the risk of a chimney fire and to ensure the performance of the fireplace. This should be done at least twice a year, as soot can build up quickly. Cold climate and burning of green or wet timber, will increase soot buildup.

Remove the internal baffles / deflectors (where applicable) inside top of the firebox to allow the soot to fall down into the appliance (raise it, move it forward, lower it and take it out).

Clean the appliance with a brush and a vacuum cleaner. Re install the metal baffles.

## 5. CLEANING THE AIR GUIDE

Certain models of the appliance are equipped with an air guide. In order to maintain good performance, it is important to clean this regularly in order to leave the window ventilation gap free.

To do so, wait for the window to cool down and scrape the inner edge of the air guide with one end of a metal instrument.

With a vacuum cleaner, remove the dust caught between the inner edge at the top and bottom of the door and the glass.

## TROUBLE SHOOTING

Problem	Possible Cause
<b>Not Enough Heat</b>	<ul style="list-style-type: none"> <li>● <b>Firewood is too moist:</b> (not seasoned enough hardwood firewood needs to be less than 20% in moisture content. ideally under 15%. Australian hardwood will take approximately 18 months to dry. Firewood with a moisture content of above 25% lowers the temperatures in the firebox dramatically.</li> <li>● <b>Firewood too large:</b> larger pieces need more primary air (air through the bottom grate).</li> <li>● <b>Air gaps under doors:</b> make sure the heater does not draw cold air from gaps under outside doors.</li> <li>● <b>Ceiling Vents:</b> warm air must not be allowed to escape into open ceiling vents.</li> <li>● <b>Incorrect flue draw:</b> make sure the flue draw is not obstructed. This may happen through build up of ash at the flue entry inside the firebox. Alternatively a bird may be caught inside the flue, or the flue is not long enough.</li> </ul>
<b>Firewood Burning Out Too Quickly</b>	<ul style="list-style-type: none"> <li>● Too much primary air.</li> <li>● Low quality firewood.</li> <li>● Excessive draft in the flue system.</li> <li>● Door seals not sealing.</li> </ul>
<b>Distortion In Firebox Grate or Grille / Door</b>	<ul style="list-style-type: none"> <li>● <b>Not emptying the ash pan regularly:</b> will result in no airflow around the grate and therefore a build up of intense heat around the cast iron grate resulting in distortion.</li> <li>● Overheating or overloading.</li> </ul>
<b>Too Much Flaky Ash</b>	<ul style="list-style-type: none"> <li>● Too much primary air.</li> <li>● Low quality firewood.</li> <li>● Firewood moisture content too high.</li> <li>● Overloading.</li> <li>● Incorrect installation.</li> <li>● <b>Not emptying the ash pan regularly:</b> will result in incorrect airflow and therefore incorrect burning.</li> </ul>
<b>Smokiness Inside The House</b>	<ul style="list-style-type: none"> <li>● Incorrect draw.</li> <li>● Unseasoned timber.</li> <li>● Leak in the flue.</li> <li>● Incorrect installation.</li> <li>● Fire not hot enough.</li> </ul>
<b>Paint Smell</b>	<ul style="list-style-type: none"> <li>● There may be a paint smell for the first few operations as the paint on the heater cures: please keep the house well ventilated during that time.</li> </ul>

## TROUBLE SHOOTING

Problem	Possible Cause
<b>Rust Inside The Firebox</b>	<ul style="list-style-type: none"> <li>● Burning green firewood.</li> <li>● Overloading.</li> <li>● Moisture able to enter through flue.</li> <li>● Burning treated timber.</li> <li>● PLEASE NOTE that some rust occurring in the firebox is unavoidable and will not cause any damage to the heater.</li> </ul>
<b>Ceiling Discolourisation</b>	<ul style="list-style-type: none"> <li>● Low oxygen levels in the house.</li> <li>● Incorrect draw.</li> <li>● Incorrect burning.</li> <li>● Leak in the flue.</li> <li>● Incorrect installation.</li> </ul>
<b>Smoke Enters Room During Start-Up</b>	<ul style="list-style-type: none"> <li>● Open the bypass.</li> <li>● Open the air control.</li> <li>● Cold Air Blockage - burn a piece of newspaper to establish a draft.</li> <li>● If the flame is not getting enough air, a small crack in the door is all that is needed.</li> </ul>
<b>Kindling Does Not Start - Fire Smolders</b>	<ul style="list-style-type: none"> <li>● Open the bypass.</li> <li>● Open the air control.</li> <li>● Not enough starter paper - use additional newspaper if necessary.</li> <li>● If the flame is not getting enough air, a small crack in the door is all that is needed.</li> </ul>
<b>Smoke Enters Room While Re-Loading</b>	<ul style="list-style-type: none"> <li>● Open deflector before opening the door.</li> <li>● Open the air control before opening the door.</li> <li>● Let the air stabilize before fully opening the door. Open the door approximately 1 inch. Let air go into the firebox for approximately 10 seconds. Once the smoke appears to be flowing up the chimney consistently, open the door.</li> <li>● Insufficient Draft - Chimney height and outside conditions can negatively affect draft. In these cases a small amount of smoke may enter the home. Adding more pipe or a draft-inducing cap may help.</li> <li>● Leak in the flue.</li> <li>● Incorrect installation.</li> </ul>
<b>Fireplace Does Not Burn Hot Enough</b>	<ul style="list-style-type: none"> <li>● Wood is Wet - see the section "Selecting Wood" on page 15 for details on wood.</li> <li>● Make sure the air control is all the way open. Slide the control back and forth to insure the control is not stuck.</li> <li>● Insufficient Draft - Chimney height and outside conditions can negatively affect draft. Adding more pipe or a draft-inducing cap may help.</li> <li>● Air gaps under doors.</li> </ul>



# HAZELLES WARRANTY POLICY

Congratulations on purchasing a Hazelles fireplace.

The Hazelles Warranty Policy set out in this document is provided to the person who purchased the Hazelles product from an authorised Hazelles reseller. The Hazelles warranties are not transferable and only applies to the original owner/purchaser.

**Please ensure to keep your original purchase invoice.**

The warranty is applied from the original date of purchase. This product must be subjected to normal use and is designed to burn Hardwood only with a maximum loading charge defined for each model.

## PERIOD OF COVER

1. 10 years limited warranty on the firebox, TQH43 models 5 years limited warranty.
2. 1 year limited warranty on cast grates, door hinges, fireplace bricks, vermiculite bricks, steel plates, baffle plates, ash pan, ceramic seals, all electrical components, control units, hot air ducting fan.

**Please note the following warranty conditions:**

- The fireplace has been operated and maintained in accordance with the operating instructions provided.
- The fireplace has been installed and connected in accordance with all applicable Australian standards, building codes and manufacturers recommendations. (refer to installation manual)
- Has not sustained damaged due to intentional force or overheating.
- Has not been modified, repaired and/or incompetent handling.

## WARRANTY EXCLUSIONS

- Any costs incurred for travelling expenses, removing, dismantling or reinstalling any fireboxes or ducting fan units.
- Freight and packaging costs to send product to and from Hazelles Australia are not covered as well as the non-use of the appliance.
- Vermiculite, fire bricks, deflector, grate, ash pan, door, frame and firebox warpage or cracks due to overheating.
- Glass breakage.
- Rust evident due to green firewood/high moisture content timber used (green firewood will result in excess rust build due to moisture and acid attacking the metal, especially when the air vents are continually shut).
- Any damage caused by overcharging, air supply altered or not recommended fuel types are used.
- Product purchased from an unauthorised Hazelles reseller, including online trading companies or individuals.
- Any damage that has occurred due to an incorrect installation.
- Failure and damage due to fair wear and tear incurred on the product during the course of normal use.

## HAZELLES WARRANTY POLICY

For the purpose of the 10 years limited warranty, fair wear and tear is defined as degradation consistent with that expected for a product of its age, when used in a regular manner and in the normal application the product was designed for.

The product must be subjected to normal use. The product is designed to burn HARDWOOD ONLY with a maximum load charge defined for each model.

Warranty will be voided if defect occurs due to operation under extreme conditions, incorrect usage or incorrect installation causing damage.

**In order to maintain your warranty, please avoid overcharging your fireplace which will produce excessive temperatures and result in damage. This can be identified by:**

- Firebox distortion/cracks.
- Fireplace door damage.
- Buckling/distortion of grille, safety bars, baffle, grate or ash pan.
- Change of colour of the heating surface.
- Discolouration of the door glass.

Only spare parts approved by Chazelles Australia may be used.

### WARRANTY CLAIMS

For any warranty claims or concerns, please contact the place of purchase or Chazelles Australia on (02) 9550 6290.

For all claims, photos of the installed fireplace, measurements and fireplace serial number must be sent with the proof of purchase invoice. Product will/may need to be returned to Chazelles Australia for assessment of all claims.

If a claim is to be made under Chazelles Australia warranty, Chazelles Australia may at its own discretion only, opt to replace the product (either with the same or similar product up to the same purchase value as the original product) or repair as required.

Chazelles Australia reserves the right to review and amend its warranty policies and periods on all products, repairs, service parts and accessories from time to time as Chazelles Australia considers appropriate.



Chazelles Fireplaces is a proud member of the Australian Home Heating Association, and as such abide by their standards. If further information is required, as well as tips for running your fireplace efficiently, we recommend visiting their website at: [www.homeheat.com.au](http://www.homeheat.com.au)





Head Office & Showroom: 396 Princes Hwy ST PETERS NSW 2044  
Tel: (02) 9550 6290 Email: [info@chazellesfireplaces.com.au](mailto:info@chazellesfireplaces.com.au) Website: [www.chazellesfireplaces.com.au](http://www.chazellesfireplaces.com.au)